



## Tringle de rideaux

Vitrage stange, Messing vernickelt  
Tringle en laiton nickelé

<b>15182</b>	30 - 45 cm	Ø 7 mm	Box à 25
	45 - 60 cm		1 x 
	60 - 90 cm		
	80 - 120 cm		

Vitrage stange, Messing vernickelt matt  
Tringle en laiton nickelé et satiné

<b>15183</b>	30 - 45 cm	Ø 7 mm	Box à 25
	45 - 60 cm		1 x 
	60 - 90 cm		
	80 - 120 cm		

Hohlringe aus Messing, Ø 15/20 mm  
Anneaux creux en laiton, Ø 15/20 mm

<b>14074</b>	messing matt	Box à 100
<b>14075</b>	messing poliert	1 x 
<b>14078</b>	vernickelt matt	
<b>14079</b>	vernickelt	

Vitrage stange, Messing  
Tringle en laiton

<b>15185</b>	30 - 45 cm	Ø 7 mm	Box à 25
	40 - 60 cm		1 x 
	60 - 90 cm		
	80 - 120 cm		

Vitrage stange, Messing matt  
Tringle en laiton satiné

<b>15186</b>	30 - 45 cm	Ø 7 mm	Box à 25
	40 - 60 cm		1 x 
	80 - 120 cm		

# Classic

## Vitrage stangen

14079 15/20 mm

15182

15183

14078 15/20 mm

15185

14075 15/20 mm

14074 15/20 mm

15186

Les caractéristiques et ces indications n'ont qu'une valeur indicative et pourront être modifiées en tout temps sans préavis. Sous réserve des variations usuelles dans les coloris.

Die Eigenschaften und Angaben können ohne vorherige Benachrichtigung geändert werden. Branchenübliche Farbabweichungen vorbehalten.

## Tringle de rideaux

# Charme

## Vitragestangen

Rohr weiss lackiert, Enden Messing vernickelt  
Tringle laqué blanc, bouts en laiton nickélé

<b>15140</b>	30 - 45 cm	Ø 8 mm	Box à	10
	45 - 60 cm	Ø 8 mm	1 x	
	60 - 80 cm	Ø 8 mm		
	80 - 140 cm	Ø 10 mm		

Rohr vermessingt, Enden Messing massiv  
Tringle en fer laitoné, bouts en laiton

<b>15141</b>	30 - 45 cm	Ø 8 mm	Box à	10
	45 - 60 cm	Ø 8 mm	1 x	
	60 - 80 cm	Ø 8 mm		
	80 - 140 cm	Ø 10 mm		

Rohr weiss lackiert, Enden Messing massiv  
Tringle laqué blanc, bouts en laiton

<b>15142</b>	30 - 45 cm	Ø 8 mm	Box à	10
	45 - 60 cm	Ø 8 mm	1 x	
	60 - 80 cm	Ø 8 mm		
	80 - 140 cm	Ø 10 mm		

Rohr und Enden nickelfarben lackiert, matt  
Tringle et bouts laqué en couleur nickel mat

<b>15143</b>	30 - 40 cm	Ø 8 mm	Box à	10
	40 - 60 cm	Ø 8 mm	1 x	
	60 - 80 cm	Ø 8 mm		
	80 - 140 cm	Ø 10 mm		

<b>15081</b>	weiss / blanc	1 x	
<b>15084</b>	braun / brun		
<b>15085</b>	vermessingt / laitoné		
<b>15086</b>	nickelfarben / coloré de nickel		

Les caractéristiques et ces indications n'ont qu'une valeur indicative et pourront être modifiées en tout temps sans préavis.  
Sous réserve des variations usuelles dans les coloris.

Die Eigenschaften und Angaben können ohne vorherige Benachrichtigung geändert werden.  
Branchenübliche Farbabweichungen vorbehalten.



**Tringle de rideaux**  
 en laiton plaqué d'or ou  
 en laiton chromé

# Romantic

**Vitrage stangen**  
 Messing vergoldet oder  
 Messing verchromt

Vitrage stange aus Messing, vergoldet  
 Tringle en laiton plaqué d'or

<b>15027</b>	30 - 45 cm	Ø 7 mm	1 x	
	45 - 60 cm	Ø 7 mm		
	50 - 80 cm	Ø 10 mm		
	80 - 140 cm	Ø 10 mm		

Vitrage stange aus Messing, verchromt  
 Tringle en laiton chromé

<b>15127</b>	30 - 45 cm	Ø 7 mm	1 x	
	45 - 60 cm	Ø 7 mm		
	50 - 80 cm	Ø 10 mm		
	80 - 140 cm	Ø 10 mm		

**15014**

**15027**  
 Ø 7 mm

**15127**  
 Ø 7 mm

**15127**  
 Ø 10 mm

Raffhaken Romantik / crochet pour embrasses

<b>15014</b>	Kopf / tête	Ø 13.5 mm	10
<b>15015</b>		Ø 7 mm	1 x 

**15015**

**15027**  
 Ø 10 mm

Les caractéristiques et ces indications n'ont qu'une valeur indicative et pourront être modifiées en tout temps sans préavis. Sous réserve des variations usuelles dans les coloris.

Die Eigenschaften und Angaben können ohne vorherige Benachrichtigung geändert werden. Branchenübliche Farbabweichungen vorbehalten.

Tringle de rideaux en laiton

*Ambiance*

Vitrageanstangen

**\*1490** 60 - 90 cm Ø 10 mm 1 x   
 80 - 130 cm  
 100 - 160 cm  
 120 - 200 cm

**\*1491** 40 - 60 cm Ø 10 mm 1 x   
 60 - 90 cm  
 80 - 130 cm  
 100 - 160 cm  
 120 - 200 cm

**15185** 30 - 45 cm Ø 7 mm Box à 25  
 40 - 60 cm 1 x   
 60 - 90 cm  
 80 - 120 cm

**\*1590** 30 - 40 cm Ø 10 mm 1 x   
 40 - 60 cm  
 60 - 80 cm  
 80 - 110 cm  
 100 - 140 cm

**\*1550** 35 - 50 cm Ø 6 mm 1 x   
 50 - 80 cm

**\*1560** 35 - 50 cm Ø 6 mm 1 x   
 50 - 80 cm

**\*1580** 40 - 60 cm Ø 9 mm 1 x 

**\*1603** 30 - 45 cm Ø10 x 5 mm Box à 25  
 40 - 60 cm 1 x   
 50 - 75 cm vermessingt  
 60 - 90 cm laitonné  
 80 - 120 cm  
 100 - 140 cm

**13408** Ø 10 mm



\* So lange Vorrat / jusqu' à épuisement du stock

Les caractéristiques et ces indications n'ont qu'une valeur indicative et pourront être modifiées en tout temps sans préavis. Sous réserve des variations usuelles dans les coloris.

Die Eigenschaften und Angaben können ohne vorherige Benachrichtigung geändert werden. Branchenübliche Farbabweichungen vorbehalten.

Rohr weiss lackiert, Enden Aluminium massiv

Tringle en fer laqué blanc, bouts en aluminium

<b>15025</b>	25 - 30 cm	Ø 7 mm	Box à 25	
	30 - 40 cm	Ø 8 mm	1 x	
	40 - 50 cm			
	50 - 60 cm			
	60 - 70 cm			
	70 - 80 cm			
	80 - 90 cm			
	90 - 100 cm			
	100 - 115 cm			
	110 - 125 cm	Ø 9 mm		



15025

Rohr vermessingt, Enden Messing massiv

Tringle en fer laitonné, bouts en laiton

<b>15024</b>	30 - 40 cm	Ø 8 mm	1 x	
	40 - 50 cm			
	50 - 65 cm	Ø 10 mm		
	65 - 80 cm			
	80 - 95 cm			
	95 - 110 cm			
	110 - 125 cm			



15024

Rohr und Enden nickelfarben lackiert, matt

Tringle et bouts laqué en couleur nickel mat

<b>15026</b>	30 - 40 cm	Ø 8 mm	1 x	
	40 - 50 cm			
	50 - 65 cm	Ø 10 mm		
	65 - 80 cm			
	80 - 95 cm			
	95 - 110 cm			
	110 - 125 cm			



15026



15131

Rohr vermessingt, Enden Messing massiv  
Tringle en fer laitoné, bouts en laiton

<b>15131</b>	30 - 40 cm	Ø 10 mm	1 x	
	40 - 60 cm			
	60 - 80 cm			
	80 - 100 cm	Ø 12 mm		
	100 - 130 cm			

Rohr weiss lackiert, Enden Messing massiv  
Tringle laqué blanc, bouts en laiton

<b>15132</b>	30 - 40 cm	Ø 10 mm	1 x	
	40 - 60 cm			
	60 - 80 cm			
	80 - 100 cm	Ø 12 mm		
	100 - 130 cm			

Rohr weiss lackiert, Enden Messing vernickelt  
Tringle laqué blanc, bouts en laiton nickelé

<b>15133</b>	30 - 40 cm	Ø 10 mm	1 x	
	40 - 60 cm			
	60 - 80 cm			
	80 - 100 cm	Ø 12 mm		
	100 - 130 cm			

Rohr und Enden nickelfarben lackiert, matt  
Tringle et bouts laqué en couleur nickel mat

<b>15134</b>	30 - 40 cm	Ø 10 mm	1 x	
	40 - 60 cm			
	60 - 80 cm			
	80 - 100 cm	Ø 12 mm		
	100 - 130 cm			

Rohr und Enden weiss  
Tringle et bouts laqué blanc

<b>15135</b>	30 - 40 cm	Ø 10 mm	1 x	
	40 - 60 cm			
	60 - 80 cm			
	80 - 100 cm	Ø 12 mm		
	100 - 130 cm			

Les caractéristiques et ces indications n'ont qu'une valeur indicative et pourront être modifiées en tout temps sans préavis. Sous réserve des variations usuelles dans les coloris.

Die Eigenschaften und Angaben können ohne vorherige Benachrichtigung geändert werden. Branchenübliche Farbabweichungen vorbehalten.



15132



15133



15134



15135

Rohr Stahl weiss lackiert  
Tringle en acier laqué blanc

**15170** 40 - 60 cm Ø 14 x 7 mm 1 x   
60 - 80 cm Box à 10  
80 - 100 cm  
100 - 120 cm  
120 - 150 cm

15170



Inklusive selbstklebender Ausgleichplatte für  
Fensterrahmen mit schräger Glasleiste.

Y compris des socles adhésifs pour égaliser des  
cadres obliques.

## Tringle de rideaux

	désignation	emballage
Ø 10x5 mm, en fer laqué blanc		
<b>1600</b>	30 - 45 cm	Box à 25
	40 - 60 cm	1 x
	50 - 75 cm	
	60 - 90 cm	
	70 - 100 cm	
	80 - 120 cm	
	100 - 140 cm	

Ø 13 mm, en acier laqué blanc		
<b>13001</b>	55 - 85 cm	1 x
	85 - 135 cm	
	135 - 225 cm	

Ø 13 mm, en acier laitonné		
<b>13002</b>	55 - 85 cm	1 x
	85 - 135 cm	
	135 - 225 cm	

## Tringles brise-bise, Ø 12 mm

fixations adhésives y compris

<b>13004</b>	en bois teinté chêne		
	60 cm col.e	1 x	
	90 cm col.e		
	120 cm col.e		

<b>13004</b>	en bois teinté pin		
	60 cm col. k	1 x	
	90 cm col. k		
	120 cm col. k		

<b>13004</b>	en bois teinté noyer		
	60 cm col. n	1 x	
	90 cm col. n		
	120 cm col. n		

<b>13004</b>	tube en acier laitonné		
	60 cm col.m	1 x	
	90 cm col.m		
	120 cm col.m		

<b>13004</b>	tube en fer plastifié blanc		
	60 cm col.w	1 x	
	90 cm col.w		
	120 cm col.w		

## Anneaux voir au registre 8

Les caractéristiques et ces indications n'ont qu'une valeur indicative et pourront être modifiées en tout temps sans préavis. Sous réserve des variations usuelles dans les coloris.

## Vorhangstangen

	Ausführung	Verpackung
Ø 10x5 mm, Stahl weiss lackiert		
<b>1600</b>	30 - 45 cm	Box à 25
	40 - 60 cm	1 x
	50 - 75 cm	
	60 - 90 cm	
	70 - 100 cm	
	80 - 120 cm	
	100 - 140 cm	

Ø 13 mm, Stahl weiss lackiert		
<b>13001</b>	55 - 85 cm	1 x
	85 - 135 cm	
	135 - 225 cm	

Ø 13 mm, Stahl vermessingt		
<b>13002</b>	55 - 85 cm	1 x
	85 - 135 cm	
	135 - 225 cm	

## Stilvitragenstangen Ø 12 mm

inkl. Selbstklebeplatte

<b>13004</b>	Holz eichefarben gebeizt		
	60 cm col.e	1 x	
	90 cm col.e		
	120 cm col.e		

<b>13004</b>	Holz kieferfarben gebeizt		
	60 cm col. k	1 x	
	90 cm col. k		
	120 cm col. k		

<b>13004</b>	Holz nussbaumfarben		
	60 cm col. n	1 x	
	90 cm col. n		
	120 cm col. n		

<b>13004</b>	Stahl, vermessingt		
	60 cm col.m	1 x	
	90 cm col.m		
	120 cm col.m		

<b>13004</b>	Stahl, weiss plastifiziert		
	60 cm col.w	1 x	
	90 cm col.w		
	120 cm col.w		

## Ringe siehe Register 8

Die Eigenschaften und Angaben können ohne vorherige Benachrichtigung geändert werden. Branchenübliche Farbabweichungen vorbehalten.





## So stellen Sie Ihre Castello-Vorhangstange zusammen:

1. Montageart wählen    2. Länge bestimmen    3. Art.-Nr. mit Farbnummer (xxx) und Endstück (?) ergänzen



Länge	Stange		Träger		Wandlager		Endstück	
	Menge	Art.-Nr.	Menge	Art.-Nr.	Menge	Art.-Nr.	Menge	Art.-Nr.
bis 70 cm	1 Stück	13080/xxx	1 Paar	13071/xxx	kein		1 Paar	1306?/xxx
bis 120 cm	1 Stück	13081/xxx	1 Paar	13071/xxx	kein		1 Paar	1306?/xxx
bis 205 cm	1 Stück	13080/xxx	2 Paar	13071/xxx	kein		1 Paar	1306?/xxx
	1 Stück	13089/xxx						
bis 255 cm	1 Stück	13081/xxx	2 Paar	13071/xxx	kein		1 Paar	1306?/xxx
	1 Stück	13089/xxx						
bis 340 cm	1 Stück	13080/xxx	2 Paar	13071/xxx	kein		1 Paar	1306?/xxx
	2 Stück	13089/xxx						

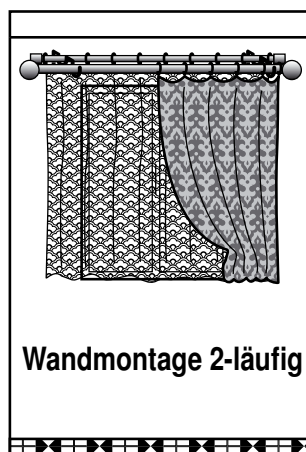

Länge	Stange		Träger		Wandlager		Endstück	
	Menge	Art.-Nr.	Menge	Art.-Nr.	Menge	Art.-Nr.	Menge	Art.-Nr.
bis 70 cm	2 Stück	13080/xxx	1 Paar	13072/xxx	kein		1 Paar	1306?/xxx
		13089/xxx					1 Paar	1306?/xxx
bis 120 cm	2 Stück	13081/xxx	1 Paar	13072/xxx	kein		1 Paar	1306?/xxx
		13089/xxx					1 Paar	1306?/xxx
bis 205 cm	2 Stück	13080/xxx	2 Paar	13072/xxx	kein		1 Paar	1306?/xxx
		13089/xxx					1 Paar	1306?/xxx
bis 255 cm	2 Stück	13081/xxx	2 Paar	13072/xxx	kein		1 Paar	1306?/xxx
		13089/xxx					1 Paar	1306?/xxx
bis 340 cm	2 Stück	13080/xxx	2 Paar	13072/xxx	kein		1 Paar	1306?/xxx
		13089/xxx					1 Paar	1306?/xxx

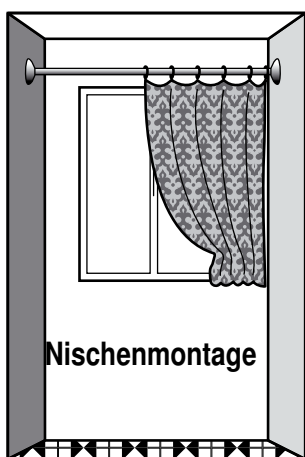

Länge	Stange		Träger		Wandlager		Endstück	
	Menge	Art.-Nr.	Menge	Art.-Nr.	Menge	Art.-Nr.	Menge	Art.-Nr.
bis 70 cm	1 Stück	13080/xxx	kein		2 Stück	13079/xxx	kein	
bis 120 cm	1 Stück	13081/xxx	kein		2 Stück	13079/xxx	kein	
bis 205 cm	1 Stück	13080/xxx	kein		2 Stück	13079/xxx	kein	
	1 Stück	13089/xxx						
bis 255 cm	1 Stück	13081/xxx	kein		2 Stück	13079/xxx	kein	
	1 Stück	13089/xxx						
bis 340 cm	1 Stück	13080/xxx	kein		2 Stück	13079/xxx	kein	
	2 Stück	13089/xxx						

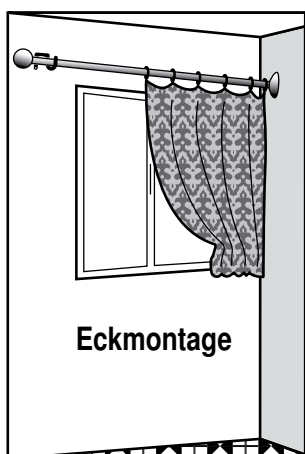

Länge	Stange		Träger		Wandlager		Endstück	
	Menge	Art.-Nr.	Menge	Art.-Nr.	Menge	Art.-Nr.	Menge	Art.-Nr.
bis 70 cm	1 Stück	13080/xxx	1 Paar	13071/xxx	1 Stück	13079/xxx	1 Paar	1306?/xxx
bis 120 cm	1 Stück	13081/xxx	1 Paar	13071/xxx	1 Stück	13079/xxx	1 Paar	1306?/xxx
bis 205 cm	1 Stück	13080/xxx	1 Paar	13071/xxx	1 Stück	13079/xxx	1 Paar	1306?/xxx
	1 Stück	13089/xxx						
bis 255 cm	1 Stück	13081/xxx	1 Paar	13071/xxx	1 Stück	13079/xxx	1 Paar	1306?/xxx
	1 Stück	13089/xxx						
bis 340 cm	1 Stück	13080/xxx	1 Paar	13071/xxx	1 Stück	13079/xxx	1 Paar	1306?/xxx
	2 Stück	13089/xxx						

# Castello 16

Nr. 13068/022  
Originalgrösse

Les caractéristiques et ces indications n'ont qu'une valeur indicative et pourront être modifiées en tout temps sans préavis. Sous réserve des variations usuelles dans les coloris.

© 2002-2006 Casatex GmbH

Nr. 13064/022  
Originalgrösse

Die Eigenschaften und Angaben können ohne vorherige Benachrichtigung geändert werden. Branchenübliche Farbabweichungen vorbehalten.

**casatex**

Nr. 13063/021  
Originalgrösse



Nr. 13080/021 Originalgrösse



Nr. 13066/022  
Originalgrösse



Nr. 13069/030  
Originalgrösse



Nr. 13061/010



Nr. 13062/020



Originalgrösse

Nr. 13060/022

Originalgrösse



**Pièces terminales Ø 13/16 mm**

**Endstücke Ø 13/16 mm**

**Farbe/Col. 010**  
matt-schwarz lackiert  
laquée noir matte

**Farbe/Col. 020**  
vermessingt  
laitonnée

**Farbe/Col. 021**  
vermessingt weiss patiniert  
laitonnée et patinée blanche

**Farbe/Col. 022**  
antik-vermessingt  
laitonnée antique

**Farbe/Col. 030**  
verchromt  
chromée



Nr. 13060/010 \* = ca. 5 mm



Nr. 13060/020



Nr. 13060/021



Nr. 13060/022



Nr. 13060/030



Nr. 13061/010 \* = ca. 10 mm



Nr. 13061/020



Nr. 13061/021



Nr. 13061/022



Nr. 13061/030



Nr. 13062/010 \* = ca. 120 mm



Nr. 13062/020



Nr. 13062/021



Nr. 13062/022



Nr. 13062/030



Nr. 13063/010 \* = ca. 110 mm



Nr. 13063/020



Nr. 13063/021



Nr. 13063/022



Nr. 13063/030

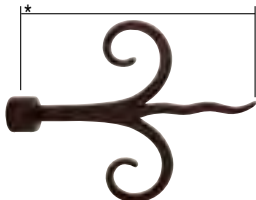

Nr. 13064/010 \* = ca. 125 mm

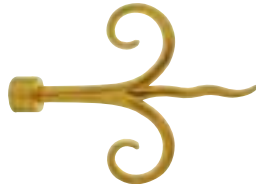

Nr. 13064/020

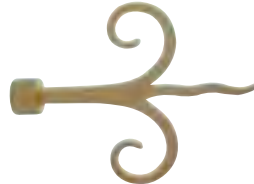

Nr. 13064/021



Nr. 13064/022



Nr. 13064/030



Nr. 13065/010 \* = ca. 110 mm



Nr. 13065/020



Nr. 13065/021



Nr. 13065/022



Nr. 13065/030

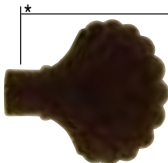

Nr. 13066/010 \* = ca. 65 mm



Nr. 13066/020



Nr. 13066/021



Nr. 13066/022



Nr. 13066/030

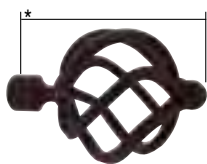

Nr. 13067/010 \* = ca. 95 mm

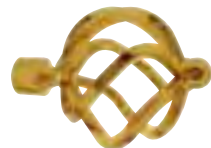

Nr. 13067/020

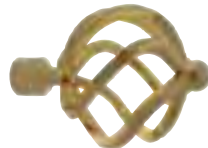

Nr. 13067/021

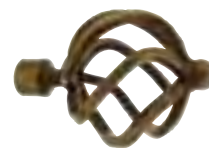

Nr. 13067/022



Nr. 13067/030

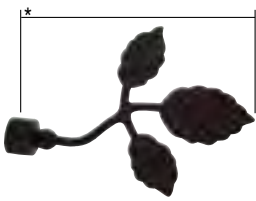

Nr. 13068/010 \* = ca. 125 mm



Nr. 13068/020

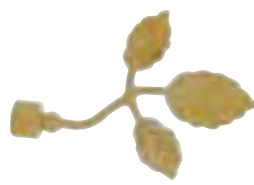

Nr. 13068/021



Nr. 13068/022

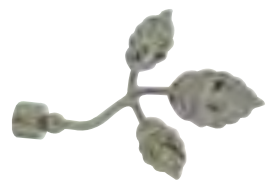

Nr. 13068/030

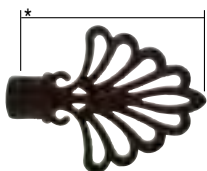

Nr. 13069/010 \* = ca. 90 mm



Nr. 13069/020

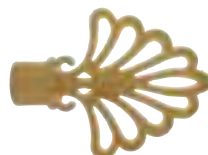

Nr. 13069/021



Nr. 13069/022



Nr. 13069/030

**Pièces supports et tringles de rideaux Ø 13/16 mm**

**Träger und Vorhangstangen Ø 13/16 mm**

**Farbe/Col. 010**  
matt-schwarz lackiert  
laquée noir matte

**Farbe/Col. 020**  
vermessingt  
laitonnée

**Farbe/Col. 021**  
vermessingt weiss patiniert  
laitonnée et patinée blanche

**Farbe/Col. 022**  
antik-vermessingt  
laitonnée antique

**Farbe/Col. 030**  
verchromt  
chromée

**Nr. 13072** Doppel-Träger für Vorhangstangen  
Support double pour tringle verstellbar/ajustable 127–147 mm



**Nr. 13072/022**



**Nr. 14066**  
vermessingt/weiss  
laitonné/blanc

Originalgrösse

verstellbar/ajustable 70–90 mm

**Nr. 13071** Träger für Vorhangstangen  
Support pour tringle



**Nr. 13071/022**



**Nr. 14060**  
schwarz/noir



**Nr. 13065/022**  
Originalgrösse



**Nr. 13080** Vorhangstange/Tringle 70–120 cm  
**Nr. 13081** Vorhangstange/Tringle 120–210 cm

**Nr. 13089** Verlängerung um 135 cm für Vorhangstangen  
Allongement 135 cm pour tringle



**Nr. 14067**  
antik-vermessingt/  
laitonné antique

Originalgrösse



**Nr. 13067/022**  
Originalgrösse



**Nr. 14069**  
verchromt/  
chromé



**Nr. 14065**  
vermessingt/  
laitonné



ca. 60 mm  
**Nr. 13090**  
Support p. rinceaux à pièce terminale  
Raffhalter-Träger für Endstücke

**Nr. 13090/022**  
Originalgrösse

## Garniture à corde tendeur

pour fixer entre murs.  
Longueur de corde 5 m.

**13092** col. 010 laquée noir 

**13092** col. 020 en acier laitonnée

**13092** col. 021 en acier laitonnée et patinée blanche

**13092** col. 022 en acier laitonnée antique

**13092** col. 030 en acier chromée

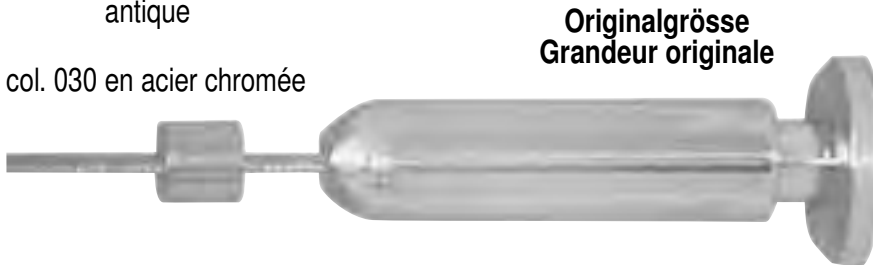

## Seilspanngarnituren

für Nischenmontage. Seillänge 5 m.

**13092** col. 010 schwarz lackiert 

**13092** col. 020 Stahl vermessingt

**13092** col. 021 Stahl vermessingt und weiss patiniert

**13092** col. 022 Stahl antik vermessingt

**13092** col. 030 Stahl verchromt

## Garniture à corde tendeur

pour fixer à la paroi. Combinable, mais n'y compris pas, avec les pièces terminales de tringle Castello. Longueur de corde 5 m.

**13093** col. 010 laquée noir 

**13093** col. 020 en acier laitonnée

**13093** col. 021 en acier laitonnée et patinée blanche

**13093** col. 022 en acier laitonnée antique

**13093** col. 030 en acier chromée

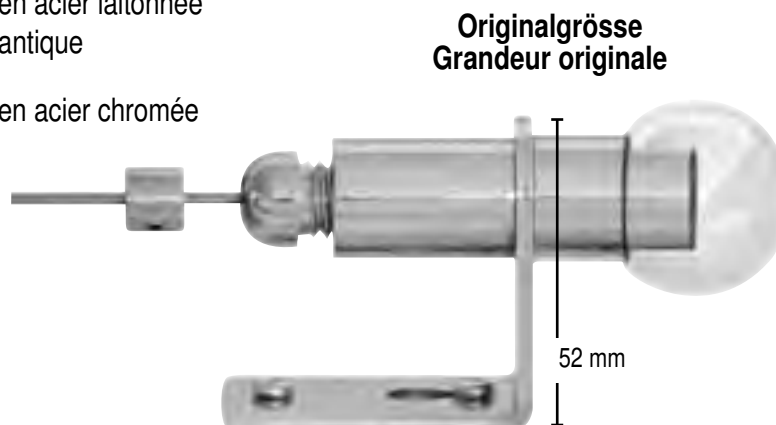

## Seilspanngarnituren

für Wandmontage. Seillänge 5 m. Kombinierbar mit Endstücken von Castello-Vorhangstangen. Endstücke nicht enthalten.

**13093** col. 010 schwarz lackiert 

**13093** col. 020 Stahl vermessingt

**13093** col. 021 Stahl vermessingt und weiss patiniert

**13093** col. 022 Stahl antik vermessingt

**13093** col. 030 Stahl verchromt

13060/xxx



13062/xxx



13064/xxx



13066/xxx



13069/xxx



13061/xxx



13063/xxx



13065/xxx

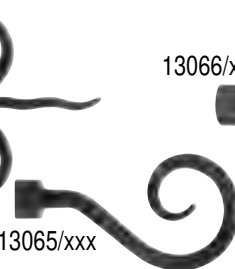

13068/xxx

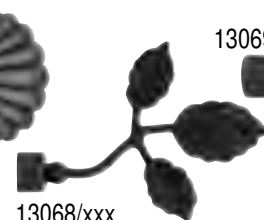

Les caractéristiques et ces indications n'ont qu'une valeur indicative et pourront être modifiées en tout temps sans préavis. Sous réserve des variations usuelles dans les coloris.

Die Eigenschaften und Angaben können ohne vorherige Benachrichtigung geändert werden. Branchenübliche Farbabweichungen vorbehalten.

## Accessoires de cordes tendeurs

**13100** **corde inoxydable**  
10 m x Ø 2 mm sac. à 1



**13420** **pincettes avec crochet S**  
nickelé Box à 100  
**13421** laitoné 20 x 



**15062** **crochet S**  
nickelé Box à 100  
**15063** laitoné 20 x 



**15069** **Crochet porte-mousqueton**  
30 mm Box à 100  
en acier nickelé



## Zubehör zu Seilspanngarnituren





**13100** **Stahlseil, rostfrei**  
10 m x Ø 2 mm Btl. à 1

**13420** **Klammer mit S-Haken**  
vernickelt Box à 100  
**13421** vermessingt 20 x 



**15062** **S-Haken**  
vernickelt Box à 100  
**15063** vermessingt 20 x 

**15069** **Karabinerhaken**  
30 mm Box à 100  
vernickelt

## Tringle de rideaux

Endstück/Embouts		
13021	/023 col. messing/laiton	1 x 
	/033 col. alu matt	
	/035 col. inox	
	/040 col. anthrazit	
13022	/023 col. messing/laiton	1 x 
	/033 col. alu matt	
	/035 col. inox	
	/040 col. anthrazit	
13023	/023 col. messing/laiton	1 x 
	/033 col. alu matt	
	/035 col. inox	
	/040 col. anthrazit	
13024	/023 col. messing/laiton	1 x 
	/033 col. alu matt	
	/035 col. inox	
	/040 col. anthrazit	

Stange mit/ Tringle avec Max-Profil		
13031	/120 cm col. messing/laiton	1 St/pc
	/160 cm	
	/200 cm	
	/240 cm	
13032	/120 cm col. alu matt	1 St/pc
	/160 cm	
	/200 cm	
	/240 cm	
13033	/120 cm col. inox	1 St/pc
	/160 cm	
	/200 cm	
	/240 cm	
13034	/120 cm col. anthrazit	1 St/pc
	/160 cm	
	/200 cm	
	/240 cm	

Träger 1-Lauf / Support single		
13038	/023 col. messing/laiton	1 x 
	/033 col. alu matt	
	/035 col. inox	
	/040 col. anthrazit	
13039	/023 col. messing/laiton	1 x 
	/033 col. alu matt	
	/035 col. inox	
	/040 col. anthrazit	

Trägerverlängerung/Rallongue support		
13040	/023 col. messing/laiton	1 x 
	/033 col. alu matt	+ 50 mm
	/035 col. inox	

	55 mm	
/999	Verbinde für Stangen/ Raccord pour tringles	1 St/pc

Les caractéristiques et ces indications n'ont qu'une valeur indicative et pourront être modifiées en tout temps sans préavis. Sous réserve des variations usuelles dans les coloris.

## Trio 16

## Vorhangstangen



13021 col.023

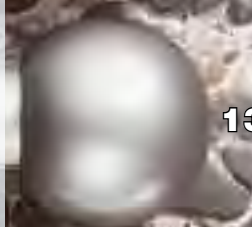

13022 col.033



13023 col.035



13024 col.040



13031-13034



13038 col.033

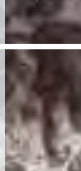

13039 col.035





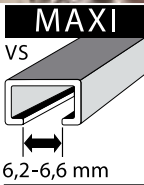



50 mm



Die Eigenschaften und Angaben können ohne vorherige Benachrichtigung geändert werden. Branchenübliche Farbabweichungen vorbehalten.



## Tringle de rideaux

Endstück/Embouts		
13041	/023 col. messing/laiton	1 x 
	/033 col. alu matt	
	/035 col. inox	
	/040 col. anthrazit	
13042	/023 col. messing/laiton	1 x 
	/033 col. alu matt	
	/035 col. inox	
	/040 col. anthrazit	
13043	/023 col. messing/laiton	1 x 
	/033 col. alu matt	
	/035 col. inox	
	/040 col. anthrazit	
13044	/023 col. messing/laiton	1 x 
	/033 col. alu matt	
	/035 col. inox	
	/040 col. anthrazit	
Stange mit/ Tringle avec Max-Profil		
13051	/120 cm col. messing/laiton	1 St/pc
	/160 cm	
	/200 cm	
	/240 cm	
13052	/120 cm col. alu matt	1 St/pc
	/160 cm	
	/200 cm	
	/240 cm	
13053	/120 cm col. inox	1 St/pc
	/160 cm	
	/200 cm	
	/240 cm	
13054	/120 cm col. anthrazit	1 St/pc
	/160 cm	
	/200 cm	
	/240 cm	
Träger 1-Lauf / Support single		
13058	/023 col. messing/laiton	1 x 
	/033 col. alu matt	
	/035 col. inox	
	/040 col. anthrazit	
13059	/023 col. messing/laiton	1 x 
	/033 col. alu matt	
	/035 col. inox	
	/040 col. anthrazit	
Trägerverlängerung/Rallongue support		
13050	/033 col. alu matt	} + 50 mm 1 x 
	/035 col. inox	
	/999 Verbinder für Stangen/ Raccord pour tringles	1 St/pc

## Trio 20

## Vorhangstangen

13041 col.023

13042 col.033

13043 col.035

13044 col.040

13051-13054

13058 col. 040

13059 col. 035

50 mm

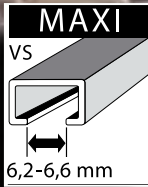

Les caractéristiques et ces indications n'ont qu'une valeur indicative et pourront être modifiées en tout temps sans préavis. Sous réserve des variations usuelles dans les coloris.

Die Eigenschaften und Angaben können ohne vorherige Benachrichtigung geändert werden. Brancheneübliche Farbabweichungen vorbehalten.